



491 W. Garfield Ave., Coldwater, MI 49036

Phone: 517-279-2135

Web/live chat: www.bds-suspension.com

E-mail: tech@bds-suspension.com

Part#: **021605, 021606**

Product: **6" Suspension System**

Application: **1988-1998 Chevy/GMC 4WD**

READ AND UNDERSTAND ALL INSTRUCTIONS AND WARNINGS PRIOR TO INSTALLATION OF SYSTEM AND OPERATION OF VEHICLE.

SAFETY WARNING BDS Suspension Co. recommends this system be installed by a professional technician. In addition to these instructions, professional knowledge of disassembly/ reassembly procedures and post installation checks must be known.

PRODUCT SAFETY WARNING Certain BDS Suspension products are intended to improve off-road performance. Modifying your vehicle for off-road use may result in the vehicle handling differently than a factory equipped vehicle. Extreme care must be used to prevent loss of control or vehicle rollover. Failure to drive your modified vehicle safely may result in serious injury or death. BDS Suspension Co. does not recommend the combined use of suspension lifts, body lifts, or other lifting devices.

You should never operate your modified vehicle under the influence of alcohol or drugs. Always drive your modified vehicle at reduced speeds to ensure your ability to control your vehicle under all driving conditions. Always wear your seat belt.

PRE-INSTALLATION NOTES

1. Special literature required: OE Service Manual for model/year of vehicle. Refer to manual for proper disassembly/ reassembly procedures of OE and related components.
2. Adhere to recommendations when replacement fasteners, retainers and keepers are called out in the OE manual.
3. Larger rim and tire combinations may increase leverage on suspension, steering, and related components. When selecting combinations larger than OE, consider the additional stress you could be inducing on the OE and related components.
4. Post suspension system vehicles may experience drive line vibrations. Angles may require tuning, slider on shaft may require replacement, shafts may need to be lengthened or trued, and U-joints may need to be replaced.
5. Secure and properly block vehicle prior to installation of BDS Suspension components. Always wear safety glasses when using power tools.
6. If installation is to be performed without a hoist, BDS Suspension Co. recommends rear alterations first.
7. Due to payload options and initial ride height variances, the amount of lift is a base figure. Final ride height dimensions may vary in accordance to original vehicle attitude. Always measure the attitude prior to beginning installation.

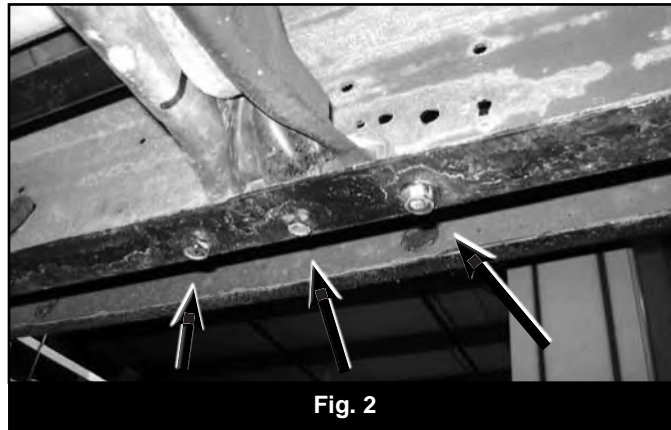
POST-INSTALLATION WARNINGS

1. Check all fasteners for proper torque. Check to ensure for adequate clearance between all rotating, mobile, fixed, and heated members. Verify clearance between exhaust and brake lines, fuel lines, fuel tank, floor boards and wiring harness. Check steering gear for clearance. Test and inspect brake system.
2. Perform steering sweep to ensure front brake hoses have adequate slack and do not contact any rotating, mobile or heated members. Inspect rear brake hoses at full extension for adequate slack. Failure to perform hose check/ replacement may result in component failure. Longer replacement hoses, if needed can be purchased from a local parts supplier.
3. Perform head light check and adjustment.
4. Re-torque all fasteners after 500 miles. Always inspect fasteners and components during routine servicing.

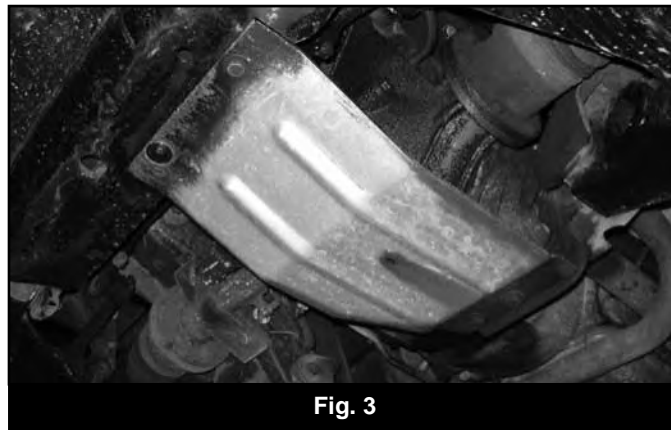
PARTS LIST

Part #	Qty	Description			
02120	1	Steering Knuckle (drv)	582	1	Bolt Pack - Sway Bar Links
02121	1	Steering Knuckle (pass)		2	7/16"-14 nylock nut
02345	1	Rear Crossmember		2	3/8"-16 x 2-1/2" bolt gr 8
02346	1	Differential Skid Plate		4	3/8" SAE washer
02125	1	Differential Drop Brkt (drv)		2	3/8"-16 prevailing torque nut
911115	2	Sway bar links	583	2	5/8" SAE washer
02129	2	Sway bar mounting bracket		2	5/8"-11 nylock nut
45313-1	2	0.625 x 0.109 x 1.375 sleeve		1	Bolt Pack - Compression Struts
SB58BK	2	Hourglass bushings		12	3/8"-16 x 1-1/4" bolt gr 8
4805G	4	Stem bushings		20	3/8" SAE washer
S10076	4	Stem bushing washers	584	8	3/8"-16 prevailing torque nut
02348	1	UCA (drv)		4	3/8"-16 serrated edge flanged nut
02349	1	UCA (pass)		1	Bolt Pack - Upper Control Arms
M02957RB	8	UCA Bushing		8	5/16"-18 x 1-1/2" bolt gr 8
96	4	0.750 x 0.095 x 2.140 UCA Sleeve	606	8	5/16" SAE washer
22510	2	Brake Line		8	5/16"-18 prevailing torque nut
5188	2	Brake Clip		1	Bolt Pack - Rear Brake Line
CCW-03-050	4	Crush Washers		2	5/16"-18 x 1 1/4" bolt gr 5
099000	4	Zip Ties		2	5/16-18 prevailing torque nut
02344	1	Front Crossmember	621	4	5/16" SAE washer
3624RB	2	Differential Drop Bushing		1	Bolt Pack - Crossmembers
15-1	1	0.750 x 0.083 x 2.950 Sleeve (diff frt)		2	5/8"-11 x 4-1/2" gr 8 bolt
02347	1	Differential Drop Brkt (pass)		2	5/8"-11 x 5-1/2" gr 8 bolt
01120	1	Torsion Bar Drop (drv)		4	5/8"-11 prevailing torque nut
01121	1	Torsion Bar Drop (pass)		8	5/8" SAE washer
02350	2	Compression Strut	633	1	Bolt Pack - Torsion Bar
02351	2	Bump Stop Bracket		2	7/16"-14 x 1-1/4" bolt gr 8
M02096RB	2	Bump Stop		4	7/16" SAE washer
N38SS	2	3/8" nut - coarse thread - non locking		2	7/16"-14 prevailing torque nut
LW38	2	3/8" lock washer		4	1/2"-13 x 1-1/4" bolt gr 8
65077	4	1/8" x 1-1/4" cotter pin		4	1/2" SAE washer
01122	1	Rear Brake Line Bracket		4	1/2"-13 prevailing torque nut
555	1	Bolt Pack - Differential Brackets		4	10mm-1.50 x 60mm bolt class 10.9
	5	1/2"-13 x 1-1/2" bolt gr 8		4	10mm flat washer
	7	1/2" SAE washer			
	2	1/2"-13 prevailing torque nut			
	1	1/2"-13 serrated edge flanged nut			
	1	9/16"-12 x 4" bolt gr 8			
	1	9/16"-12 x 4-1/2" bolt gr 8			
	2	9/16"-12 x 1-1/2" bolt gr 8			
	8	9/16" SAE washer			
	4	9/16"-12 prevailing torque nut			

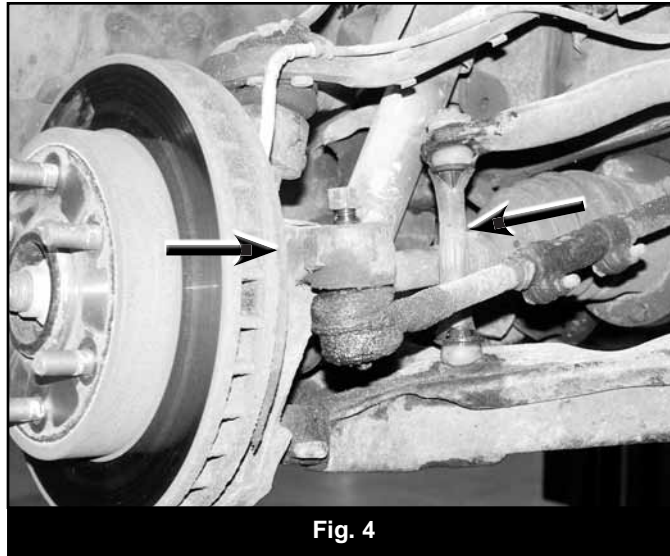
8. Unload the torsion bar assemblies. **CAUTION:** The torsion bars are under extreme pressure. Use the correct unloading tool to remove the pressure on the torsion bars before attempting to remove the assembly. A J36202 or equivalent torsion bar unloading tool must be used. Be sure to follow the OE manual and the torsion bar unloading tool literature as to how to unload the torsion bars.
9. Mark the unloaded torsion bars to indicate passenger's and driver's side. Mark both of the torsion bars to indicate the front versus the rear for later installation. Also mark the torsion bars relative to the control arms at the front to note indexing. Mark the rear of the bars relative to the adjusting arms to indicate indexing.
10. Drive the torsion bars forward using a maul or an air hammer through the access hole in the back of the torsion bar crossmember. This will allow the adjuster keys to fall free.
11. Remove the bolts holding the torsion bar crossmember to the frame (Fig 2). Retain these fasteners with the crossmember after removal. Remove the crossmember. Note: It may be necessary to remove a portion of the exhaust system on some vehicles in order to complete this operation.



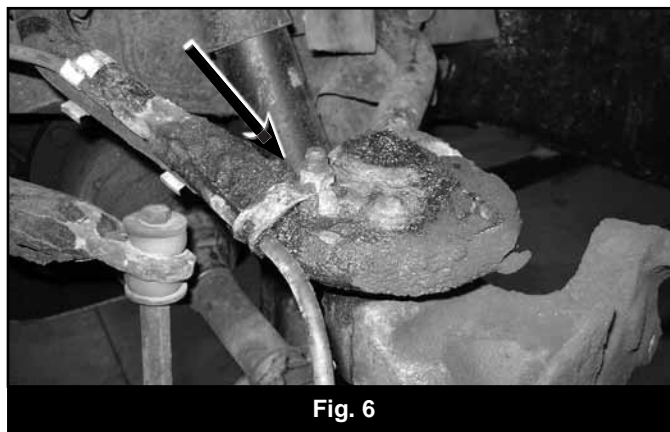
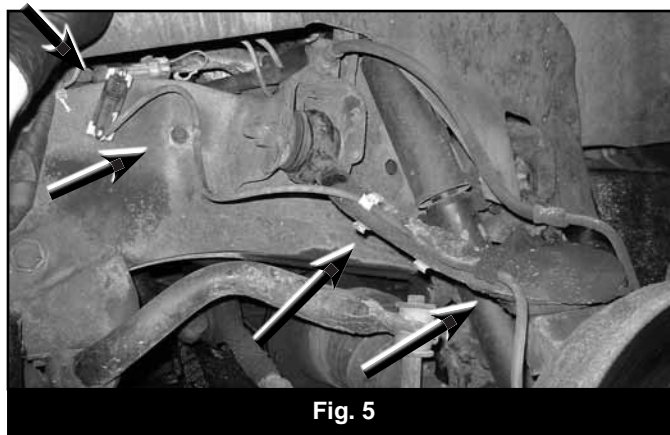
12. Remove the torsion bars by pulling them toward the rear of the vehicle, out of the lower control arms.
13. If equipped, remove the front factory differential skid plate (Fig 3) from the vehicle. This will not be reused.



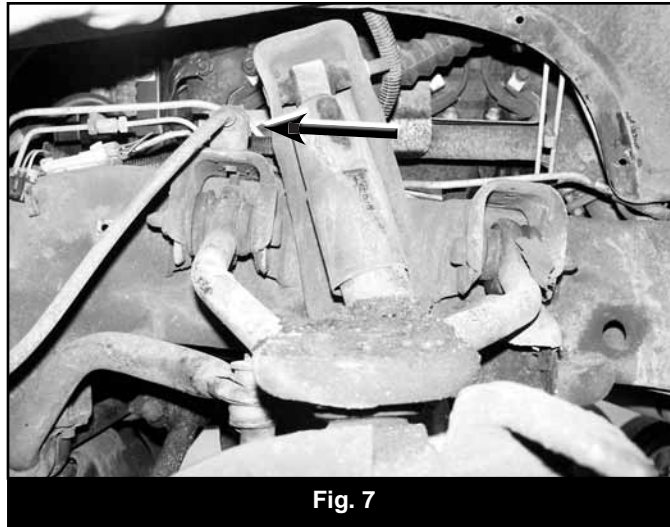
14. Remove the sway bar end links from the sway bar and lower control arms. (Fig 4) Discard the end links. The plastic plug will need to be removed from the lower control arm to access the link bolt.
15. Remove the shocks. Discard the shocks and retain mounting hardware.
16. Disconnect the tie rod ends from the steering knuckles. Remove and retain the mounting nuts. Strike the steering knuckle at the tie rod end to dislodge the end (Fig 4). Take care not to damage the tie rod end.



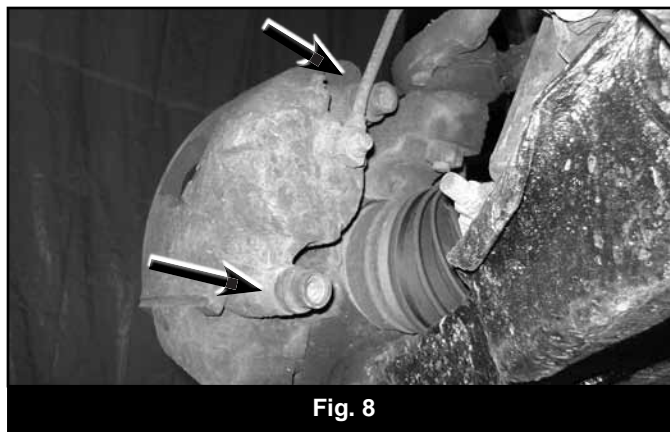
17. If equipped, disconnect the ABS brake wire from the frame and the control arm (Fig 5, 6). Disconnect the ABS connector at the frame.



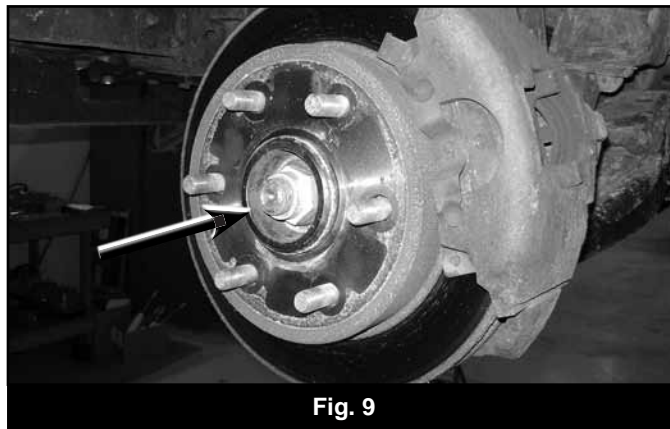
18. Disconnect the brake line clip from brakeline (Fig 7), located above the upper control arm. Disconnect the rubber flexline from hardline at this location with a line wrench.



19. Disconnect the rubber brakeline from the caliper. Discard old brass crush washers (2), retain banjo bolt (Fig 8).
20. Attach new brakeline to upper mount first, tighten to approximately 25 ft-lbs.
21. Install new brass crush washers on each side of brakeline at caliper. Attach with OE bolt, torque to 20 ft-lbs. Repeat brake line installation on remaining side.
22. Remove the brake caliper anchor bracket bolts and pull the caliper free from the steering knuckle and rotor (Fig 8). Hang the caliper securely out of the way. Retain caliper mounting hardware. Remove the brake rotor from the hub.
Note: Do not allow the brake caliper to hang from the brake hose.



23. Remove the axle shaft hub nut and save (Fig 9).



24. Disconnect the CV axles from the differential by removing the mounting flange bolts, keep bolts for reinstallation (Fig 10).

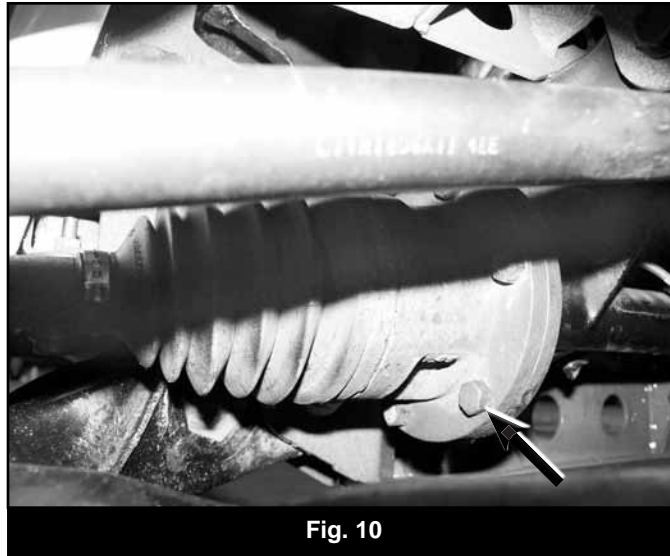


Fig. 10

25. Remove the upper and lower ball joint nuts. Reinstall the nuts a few turns by hand. Dislodge the upper and lower ball joints from the steering knuckle by striking the knuckle near each joint with a hammer. Remove the upper ball joint nut and allow the knuckle/CV axle and lower control arm to swing down. Remove the CV axle from hub. (Fig 11)

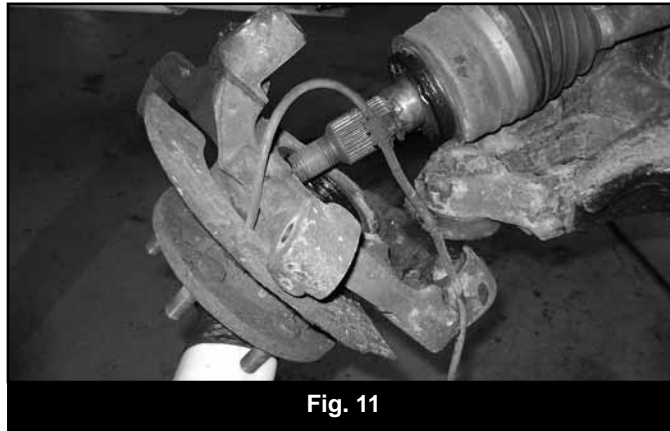


Fig. 11

26. Remove the lower ball joint nut and remove the knuckle from the lower control arm. Retain the ball joint nuts.
 27. Remove the lower control arm pivot bolts and remove the control arm from the vehicle. Save hardware.
 28. Remove the OE lower control arm bump stops from the frame (Fig 12). The nut is accessed from the top of the mount.

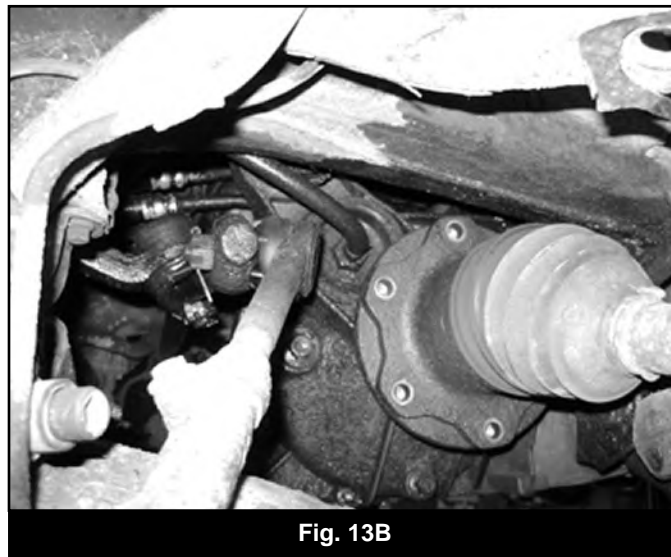
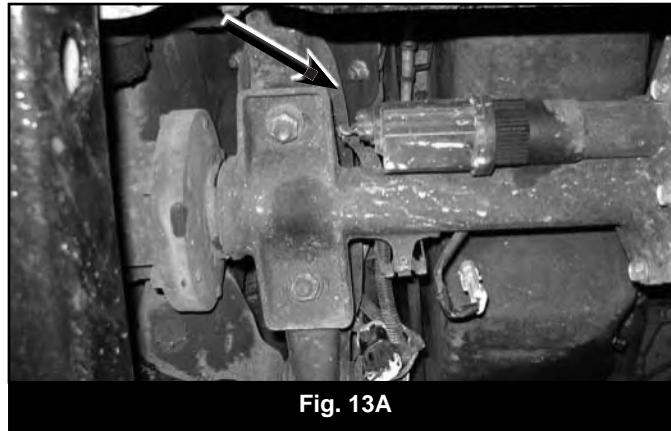


FIG 12

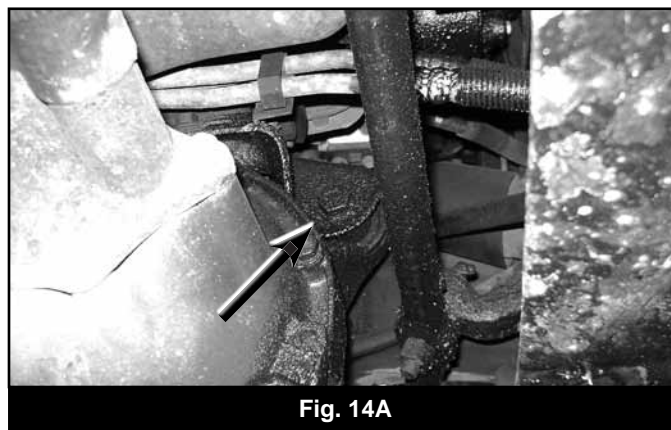
29. Make index marks to relate the front driveshaft to the mating components before removal. Disconnect the front driveshaft from the differential housing and transfer case and remove it from the vehicle, retain all mounting hardware. Driveshaft notes: Be sure not to allow the two sections of the driveshaft to separate. It may not be

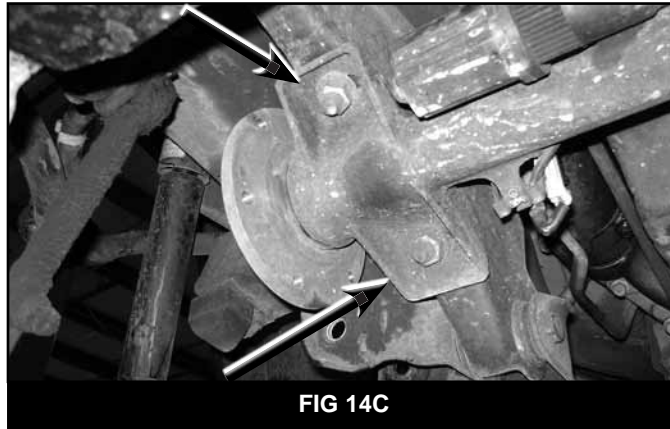
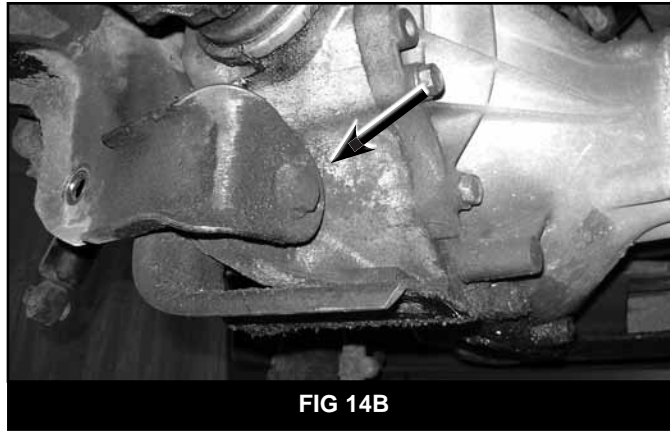
necessary to remove the driveshaft completely, if the exhaust modifications are completed prior to driving the vehicle or it is a short distance to the muffler shop, it may be easier to disconnect the driveshaft from the differential. It can be hung up out of the way temporarily. Some newer models may have a light-duty CV style joint at the transfer case and this method of driveshaft removal will be necessary.

30. Disconnect the breather line from the driver's side of the front differential. Disconnect the electrical connector from the differential actuator, remove the wire from retaining clips on the differential and pull the wire out of the way. (Fig 13A,B).

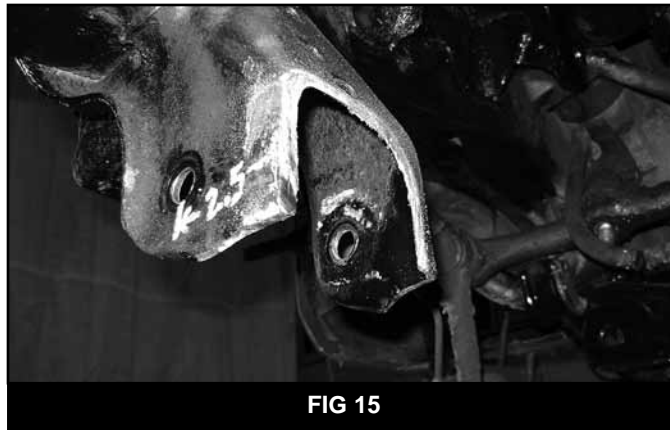


31. Support the front differential with an appropriate jack and remove the driver's side front (Fig 14A) and rear mounting bolts (Fig 14B) as well as the two mounting nuts on the passenger's side (Fig 14C). Retain all hardware. To gain additional clearance for removal, pull the steering all the way to the left. Remove the differential from the vehicle. Note: Removal of the rear driver's side frame mounting tab can aid in differential removal. It will be cut of in the next step.

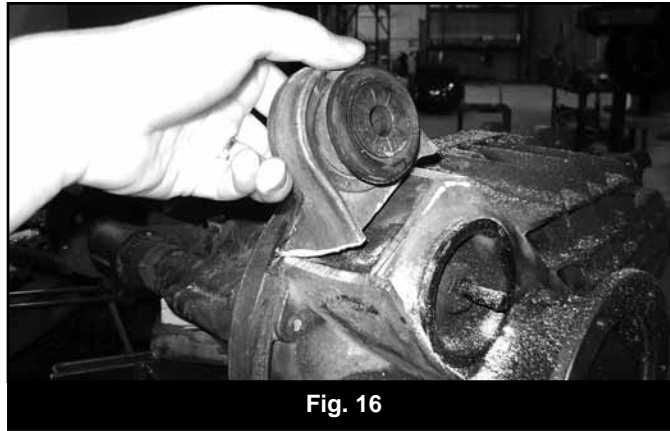




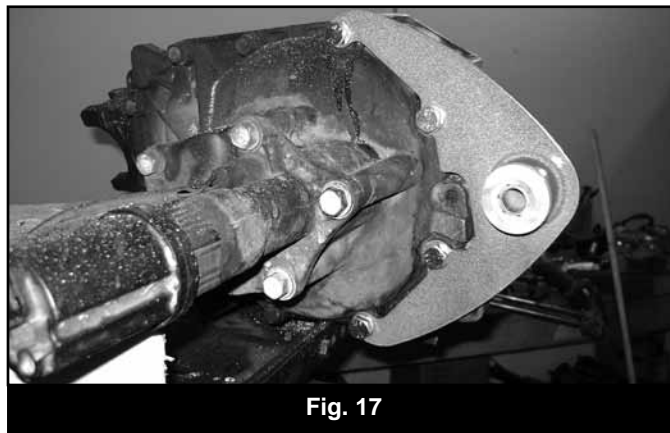
32. The driver's side rear differential mount must be removed (Fig 15). Measure 2-1/2" in from the factory lower control arm mounting hole and make a vertical cut line on the front and rear surfaces. Connect the vertical cut lines across the top of the pocket. Using a sawzall or cut-off tool remove the differential mount from the frame. Note: Always check for fuel lines and/or electrical wires before cutting. Undercoating is flammable. Paint bare metal to prevent corrosion.



33. The front driver's side differential mounting eye must be removed from the differential (Fig 16). Mark the eye with a cut line smooth to the housing. Using a sawzall, cut the mounting eye off of the housing. Do not cut into the main housing body.

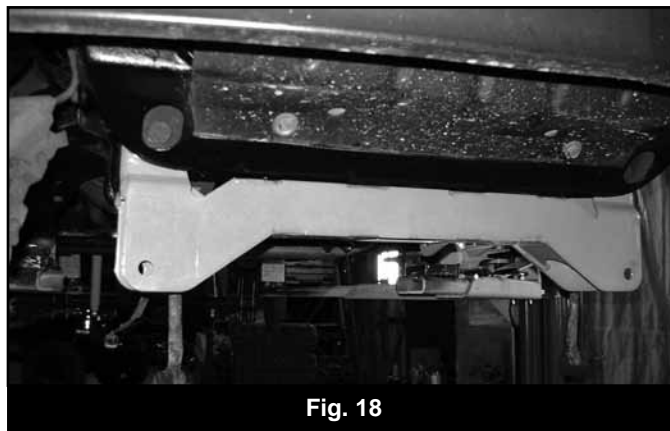


34. Install the bushings (3624RB) and $\frac{3}{4}$ " x 2.955" sleeve (15-1) in the new differential bracket (02125). Line the bracket up to the differential case bolts to determine which bolts to remove. Remove the appropriate bolts and install the bracket with four 10mm x 60mm bolts and 10mm flat washers (BP 633) (Fig 17). Use Loctite® on the threads and torque to 30 ft-lbs.



- ⓘ *Crossmember Installation Notes: BDS crossmembers have slotted mounting holes to ease installation and compensate for any variances in OE frame bracket locations. Once the crossmembers are installed, visually center the crossmembers in the frame before the mounting bolts are tightened. Before installing either crossmember, be sure that the inside surfaces of the OE lower control arm pockets are free of burrs. Commonly, the OE bolts and washers stretch the mounting holes when installed and leave a rolled edge that could hinder the installation of the new crossmembers. These edges can be smoothed with a file or rotary grinding tool.*

35. Install the new front crossmember (02344) in the lower front OE control arm pockets using the original control arm pivot bolts, nuts and washers (Fig 18). Install bolts from front to rear and leave loose.



36. Install the provided passenger's side differential bracket (02347) to the OE differential mounting studs and retain with the original nuts and washers (Fig 19). Leave hardware loose. The wide end of the bracket goes to the front and the open side faces inward.

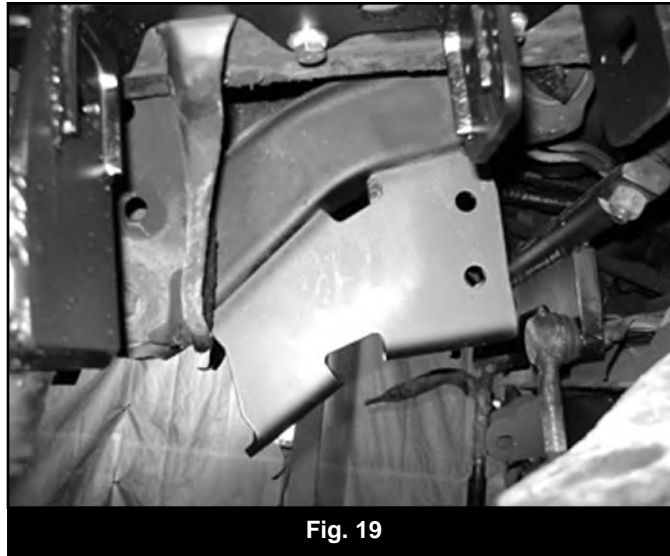


Fig. 19

37. Raise the differential and attach to the new front crossmember tabs with a 9/16" x 4-1/2" bolt, nut and washers (BP 555). Leave hardware loose. (Fig 20A)

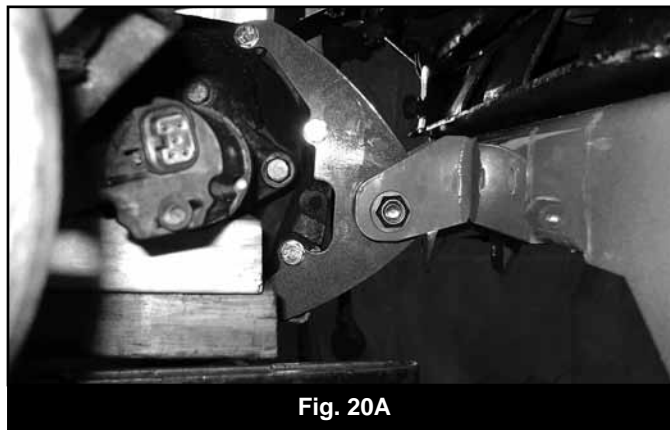


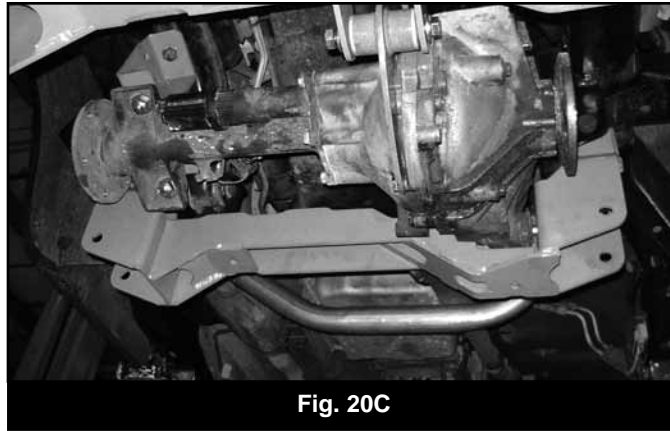
Fig. 20A

38. Fasten the passenger's side of the differential to the new bracket with two 9/16" x 1-1/2" bolts, nuts and 9/16" washers (BP 555). Snug hardware (Fig 20B).

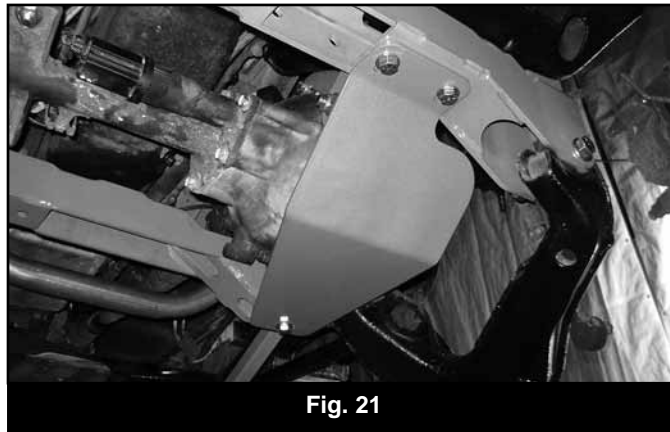


Fig. 20B

39. Install the new rear crossmember (02345) in the lower rear OE control arm pockets will aligning the differential mount. Fasten the crossmember to the frame with the original control arm pivot bolts, nuts and washers. The bolt heads must be to the front of the vehicle. Fasten the differential to the crossmember with a 9/16" x 4" bolt, nut and washers (BP 555). Leave mounting bolts loose (Fig 20C).



40. Reconnect the electrical wires and breather hose to the differential. It may be necessary to gain slack for the breather hose up in the engine compartment.
41. Install the new differential skid plate (02346) to the welded nuts on the front and rear crossmembers with $\frac{1}{2}$ " x 1-1/4" bolts and $\frac{1}{2}$ " SAE washers (BP 555). The inside front hole on the front crossmember will require a 1/2" serrated flanged nut (BP 555). Use Loctite on the bolt threads. Leave hardware loose. (Fig 21)



42. Trim the welded on steering stops from the lower control arm front and rear (Fig 22A, B). Do not cut into the main body of the control arm. Removing the steering stops will allow the truck to have a better turning radius. Later model trucks have forged control arm ends. Trim the steering stops flush on the control arm end as shown in Figure 23A,B.

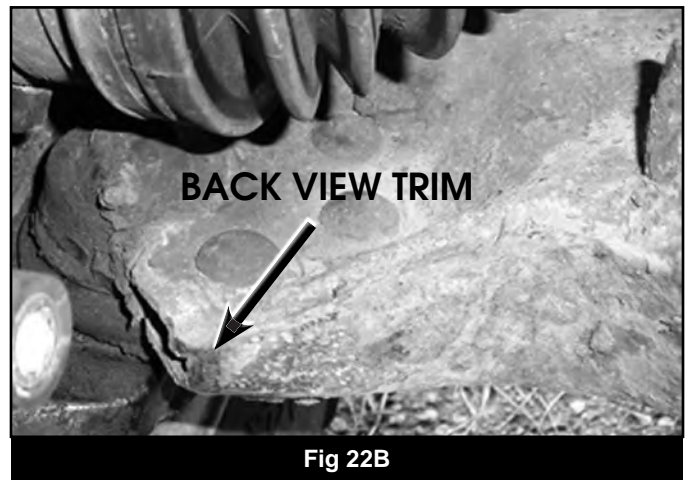




Fig. 23A



Fig. 23B - trimmed

43. Install the OE lower control arms in the front and rear crossmembers with 5/8" x 4-1/2" bolts (front), 5/8" x 5-1/2" bolts (rear), nuts and 5/8" SAE washers (BP 621). Leave hardware loose. The heads of the bolts must be to the front of the vehicle (Fig 24).

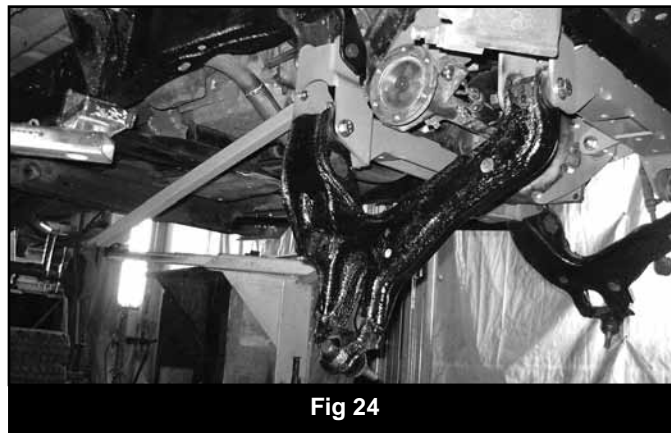


Fig 24

44. Tighten the following hardware in this order:

- *Front and rear crossmember pocket bolts to 125 ft-lbs*
- *Driver's side differential bolts to 70 ft-lbs*
- *Passenger's side differential bolts and nuts to 70 ft-lbs*
- *Differential skid plate bolts to 50 ft-lbs*

45. Attach the new supplied compression struts to the rear crossmember. Position the struts so the opposite end sets flat to the transmission crossmember. (Fig 25B) Fasten the compression struts to the rear crossmember with 3/8" x 1-1/4" bolts, washers, and nuts. Snug hardware so the compression struts are squared up to the back of the crossmember. (Fig 25A)

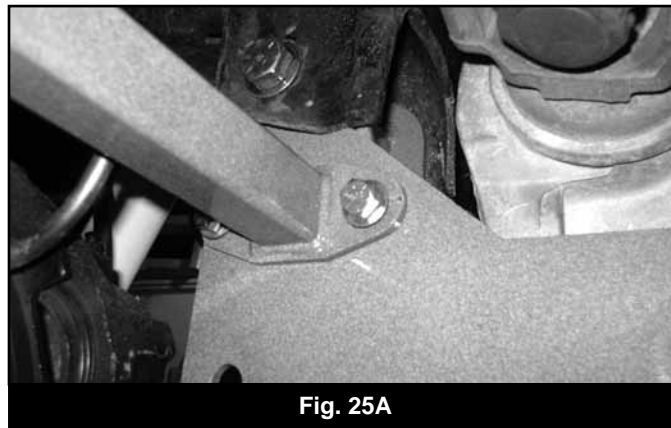


Fig. 25A

46. Position the compression strut to the transmission crossmember. Mark the holes on the crossmember for drilling. Note: Some vehicles may have a transfer case skid plate mounting off of the transmission crossmember that may interfere with the rear strut mount. If this is the case remove the skid plate. It can either be modified to clear the new mount or left off. (Fig 25B)

**FLANGED NUT INSIDE
CROSSMEMBER**

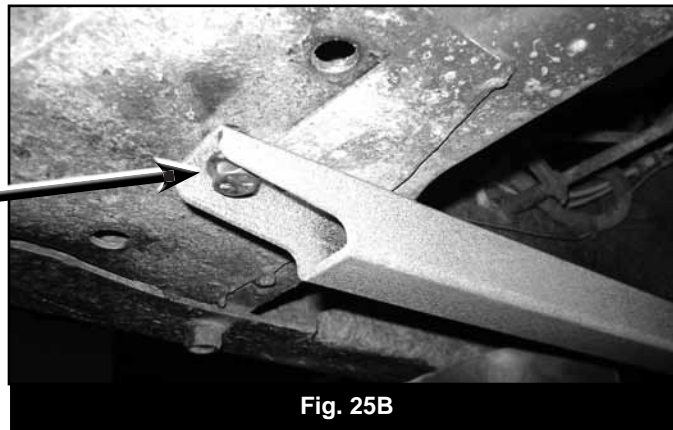


Fig. 25B

47. Drill 7/16" holes at the marks on the transmission crossmember through the first layer of metal only.
48. Attach the compression struts to the transmission crossmember with 3/8" x 1-1/4" bolts and washers on the compression strut side, and 3/8" flanged nuts inside the crossmember. Torque bolts to 30 ft-lbs. Go back and torque the mounting bolts at the rear crossmember to 30 ft-lbs.
49. Locate the original bump stop mounting holes on the frame. Drill the smaller back hole out to 3/8" (Fig 26A). Install the provided bump stop brackets with 3/8" x 1-1/4" bolts, nuts and washers (BP 583). Tighten hardware to 30 ft-lbs. Install the new polyurethane bumpstop into the front hole of the bracket with the provided 3/8" lock washer and non-locking nut. Tighten securely. (Fig 26B)

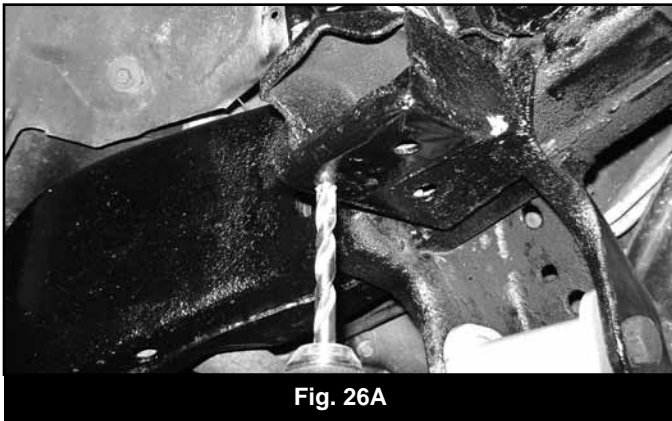


Fig. 26A

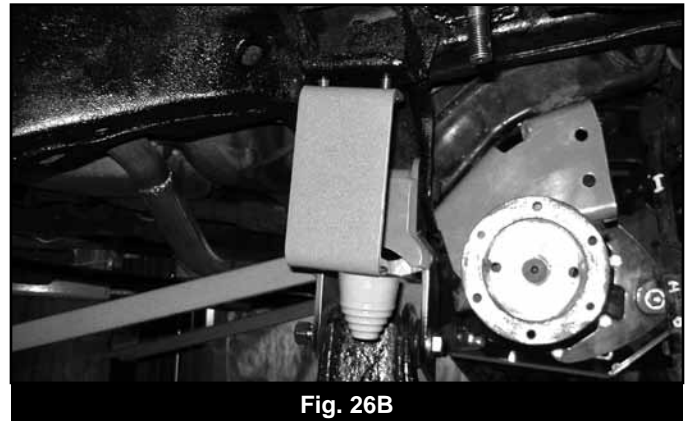


Fig. 26B

50. Working on the upper control arm frame pockets, inspect the control arm mounting holes. If the vehicle has never been aligned the factory alignment knockouts will still be intact. These will need to be removed in order to properly align the vehicle after the lift is installed. Removing the knock outs will change the mounting hole to slots. These can be removed with a hammer and chisel or with a rotary grinding tool (die grinder). The knock out sections are pre-stamped from the factory for easier removal (Fig 27).

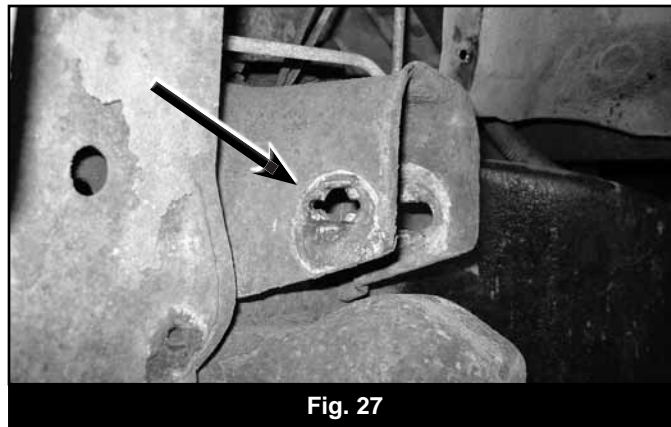
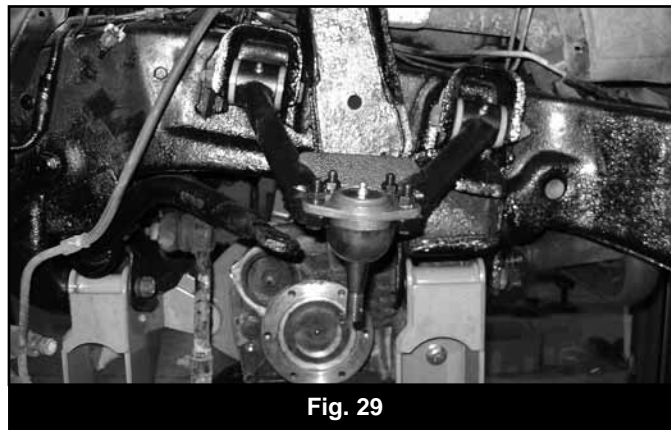


Fig. 27

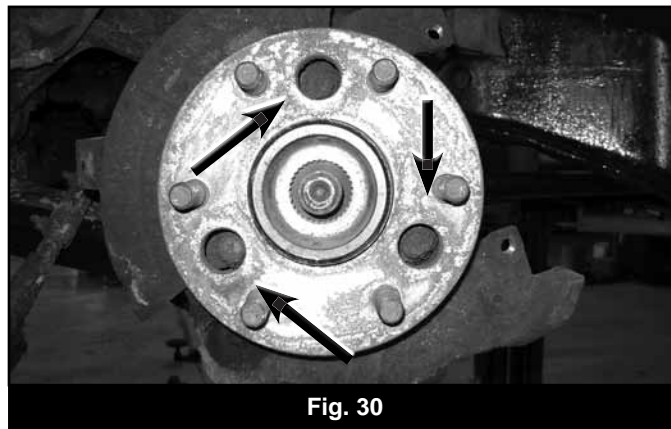
51. Grease and install the bushings (M02957RB) and sleeves (96) into the new provided upper control arms (02348, 02349). Install the provided grease fittings into the thread holes in each arm end (4 total).
52. If reusing, remove the balljoints from the factory upper control arms and install onto the topside of the replacement control arms with 5/16" x 1-1/2" bolts, nut and washers (BP 584). There will not be a washer on the head of the bolt. Run the bolt from bottom - up. Tighten securely to 30 ft-lbs. If using new ball joints (recommended), install the same way using the BDS provided hardware (Fig 28).



53. Install the control arms into the vehicle. The arms are driver's/passenger's side specific. When installed properly the ball joint end of the control arm will be nearly parallel with the ground. (Fig. 29 - Driver's side shown)



54. Locate the factory steering knuckle assembly removed earlier. Remove the three bolts mounting the hub bearing assembly to the OE steering knuckle. The bolts are accessed through holes in the wheel mounting flange. Retain the mounting bolts. Remove the hub assembly from the knuckle. Note: It may be necessary to press the hub out of the knuckle as a result of excessive corrosion on some vehicles. (Fig 30)



55. Carefully remove the large seal from the backside of the knuckle, if equipped (Fig 31). This can be done carefully using a hammer and large punch. Install the seal into the new supplied steering knuckles (02120, 02121). Install the factory hub assemblies into the new knuckles and fasten with the stock bolts. Use Loctite on the bolt threads and torque to 125 ft-lbs. Note: The factory dust shield will not be reused.

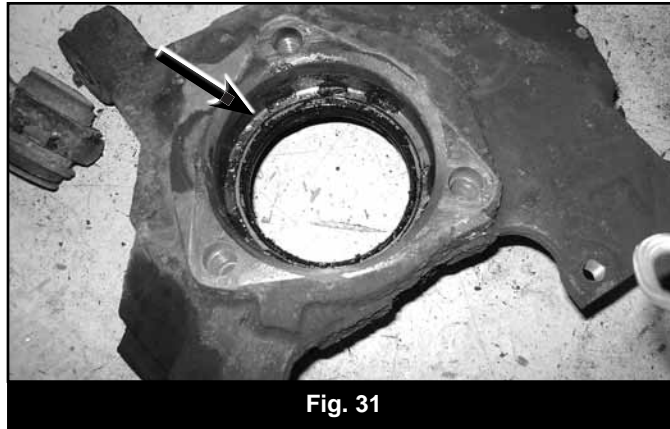


Fig. 31

56. Attach the new knuckle assembly to the upper and lower ball joints and fasten with the OE nuts. Torque the upper ball joint to 74 ft-lbs and the lower to 94 ft-lbs.
57. Mark and disassemble the tie rod end assembly (Fig 32). Remove the center adjusting collar and trim 1/2" from each end. The center section should be approximately 4" long after modification. Trim the tie rod ends to 6-3/4"-6-7/8" long (Center of the head to the end of the threads) and reassemble (remember the ends are right and left hand threaded). Adjust the final assembly to 14" long (center to center) and reinstall on the vehicle. Make sure that there are an even number of threads left on both the inner and outer tie rod ends. This measurement is a good starting point and will need to be adjusted in order to get the final alignment specifications set.



Fig. 32

58. Install the tie rod ends into the new knuckle steering arm from the top down. Fasten with the OE nut and torque to 40 ft-lbs. Tighten the hardware for the adjusting collar.
59. Install the CV axles in the hubs and fasten with the OE axle nut. Be sure that the axle is fully seated in the hub and torque the axle nut to 173 ft-lbs. Install the axle nut cover if equipped.
60. Attach the CV shaft to the differential with the factory hardware. Use Loctite on the bolt threads and torque to 55 ft-lbs.
61. Install the brake rotor on the hub then install the brake caliper on the rotor/knuckle and fasten with the OE mounting bolts. Use Loctite on the bolt threads and torque the caliper bolts to 75 ft-lbs. Be sure that the brake hose is routed behind the knuckle and under the upper control arm.
62. Attach the ABS wire to the upper control arm with the provided wire ties and reconnect the wire connector at the frame.
63. Double check brake hoses and ABS wires for clearance of all moving objects. Do a steering sweep to check for clearances.
64. Lightly grease and install bushings into both ends of shocks. Long sleeve goes into the top of shock, with spacers. Large spacer goes to rear of truck. (Fig 33A,B) Install the new BDS shocks with OE mounting hardware. Torque bolts to 35 ft-lbs



Fig. 33A

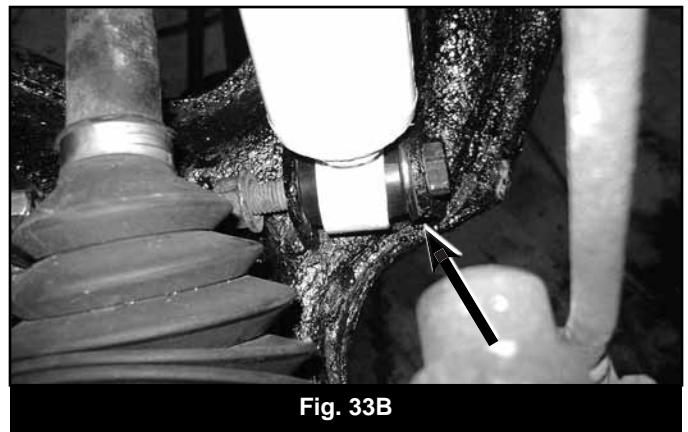


Fig. 33B

65. Loosely install the provided sway bar link u-brackets (02129) to the lower control arm. Rotate the bracket so the mounting holes will be parallel with the lower control arm hardware (everything pivots in the same axis - Fig 34A). Tighten securely with 5/8" nylock nut and washer (BP 582). Install Tip: Tape the u-bracket mounting nut and washer together in install through the control arm so you don't drop the washer into the arm (Fig 34B).
66. Install the provided hourglass bushings (SB58BK) and sleeves (45313) in the eyes of the new sway bar end links (911115). Install the links in the u-bracket mounted on the lower control arms. Attach to the sway bar with the provided stem bushings and washers. Tighten nylock nut until the bushings begin to expand. Do NOT overtighten. (Fig 34A)

BOLTS PARALLEL



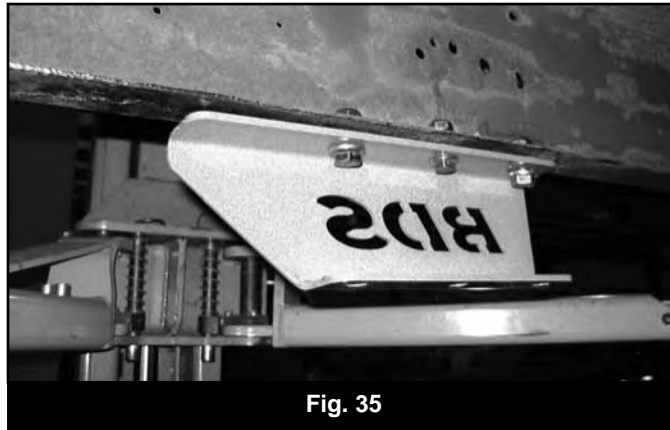
Fig. 34



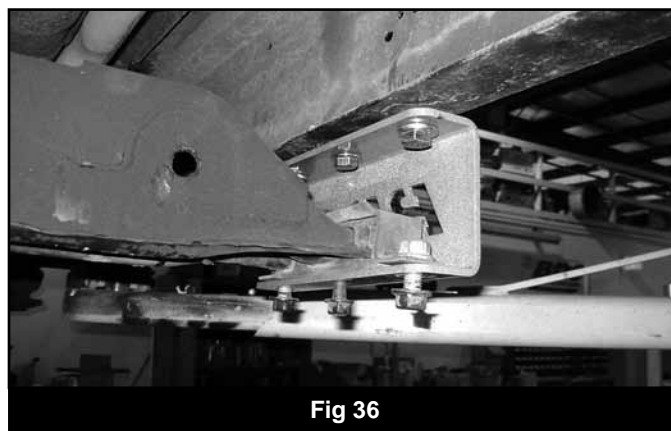
Fig. 34B

67. With the links completely installed, tighten the 3/8 hardware to 30 ft-lbs and the 5/8" hardware to 75 ft-lbs.
68. Attach the driveshaft to the differential with the original mounting hardware. Use Loctite on the bolt threads and torque to 19 ft-lbs. Note: The exhaust modification must be done before reattaching the front driveshaft.

69. Install the driver's and passenger's side torsion bars in the front lower control arms using the index marks made earlier. Slide the bars forward about one foot.
70. Position the new torsion bar crossmember drop brackets (01120-drivers side, 01121-pass side) on the frame directly below the original mount. Loosely fasten with ½"x1-1/4" bolts, nuts and washers (BP 633) at the two outside mounting locations and 7/16" x 1-1/4" bolt, washers, and nut in center mounting position. (Fig 35)



71. Install the torsion bar crossmember to the new drop bracket with the OE hardware and torque 12mm hardware to 46 ft-lbs, 10mm 18 ft-lbs. (Fig 36)



72. Install the driver's and passenger's torsion bars into the factory adjusters and crossmember using the index marks made earlier. Load the torsion bars with the appropriate tools and set adjuster bolts to the measurements made before disassembly. Do not adjust the torsion bars higher than 27-1/2" from the bottom of the fender to the center of the front hub with the vehicle setting on flat ground and the suspension settled properly.
73. Install the front wheels and torque the lug nuts to the appropriate specifications. Spin the wheels and do a steering sweep to check for any binding or clearance issues.
74. Lower the vehicle to the ground and bounce it to settle the suspension. Torque the lower control arm bolts to 125 ft-lbs.
75. Bleed front brakes, starting with wheel farthest from brake reservoir.
76. Double check all fasteners.

REAR INSTALLATION

1. Raise the rear of the vehicle and support the frame with jack stands just ahead of the spring hangers.
2. Remove the wheels.
3. Support the rear axle with a hydraulic jack under the differential and remove the OE shocks. Retain hardware.
4. Disconnect the rear brake line bracket from the frame rail by removing the two bolts mounting the bracket to the inside of the driver's side frame rail (Fig 37). Retain hardware.

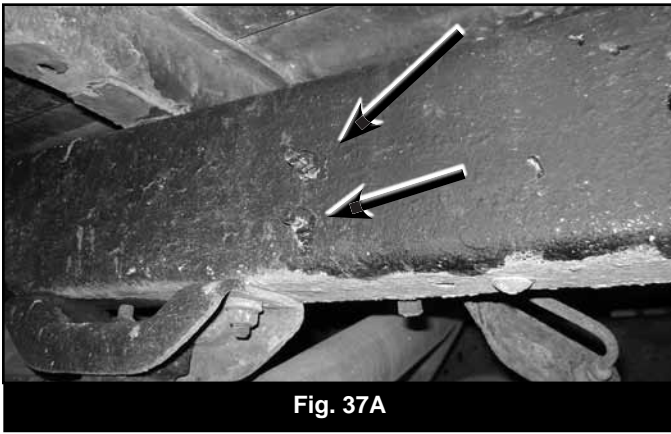


Fig. 37A

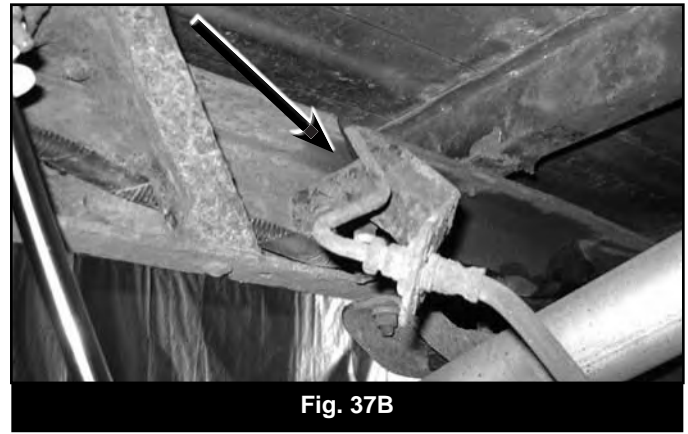


Fig. 37B

5. While supporting the axle with a floor jack, remove the passenger's side u-bolts. Lower the axle from the spring.

Lift Block and Add-a-Leaf Installation

6. Using two large C-clamps, clamp the leaf spring near the center pin to hold the leaf pack together and remove the center pin nut.
7. Slowly release the C-clamp to allow the leaf pack to separate. Remove the center pin.
8. Remove the OE leaf alignment clamps. Replace these clamps with the supplied bolt style alignment clamp 01113. After removing the OE clamp and rivet, install the new clamp with an 8mm flathead screw and nut from bolt pack 506 (Fig 38). Torque hardware to 20 ft-lbs.

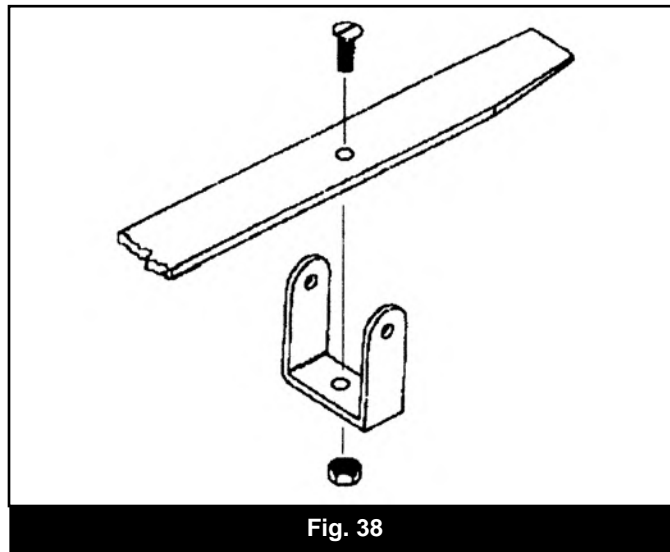


Fig. 38

9. Place the long add-a-leaf between the second and third leaf in the pack. Place the remaining leaves under the new leaf in the order they were removed.
10. Slide the new 3/8" center pin up through the leaf pack and start the nut to hold the pack together. Note: DO NOT use the center pin to draw the leaf pack together.
11. Use a C-clamp on each side of the center pin to draw the pack together. After the pack is together torque the center pin to 30 ft-lbs and remove the C-clamps.
12. Install the supplied sleeves between the leaf alignment clamps using the 3/8" x 3-1/2" bolts, nuts and washers from bolt pack 506. Torque to 30 ft-lbs.
13. Position the block between the spring pack and the axle spring perch. Make sure the short end of the block taper is to the front of the vehicle.
14. Slowly raise the axle while aligning the pins/holes in the leaf pack, block and spring perch.
15. Install the provided u-bolts, nuts and washers and snug the assembly together. Final u-bolt torque will be performed with the vehicle on the ground (Fig 39).

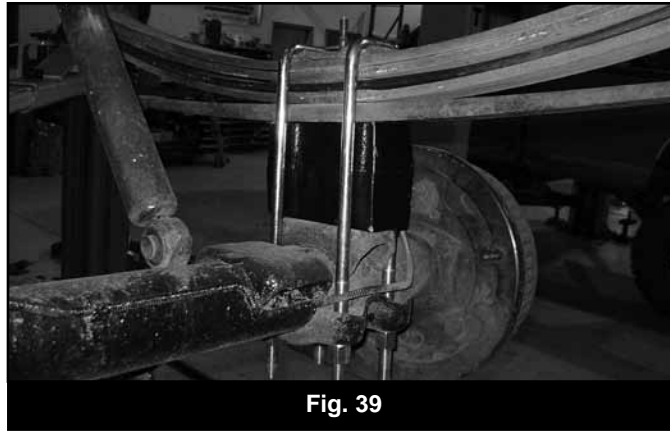


Fig. 39

16. Repeat on driver's side of the vehicle.

Replacement Spring Installation

17. Lower the axle from the spring. Remove the front spring hanger bolt and rear spring shackle-to-frame bolt and remove the spring from the vehicle.
18. Remove the shackle from the OE spring and loosely install it on the corresponding end of the BDS spring.
19. Install the new spring in the vehicle with the OE mounting bolts and leave bolts loose.
20. Align the spring pin and the axle perch hole and raise the axle. Install the provided u-bolts and snug them to the axle. Final torque of the u-bolts will be done with the weight of the vehicle on the axle.
21. Repeat on driver's side of the vehicle.

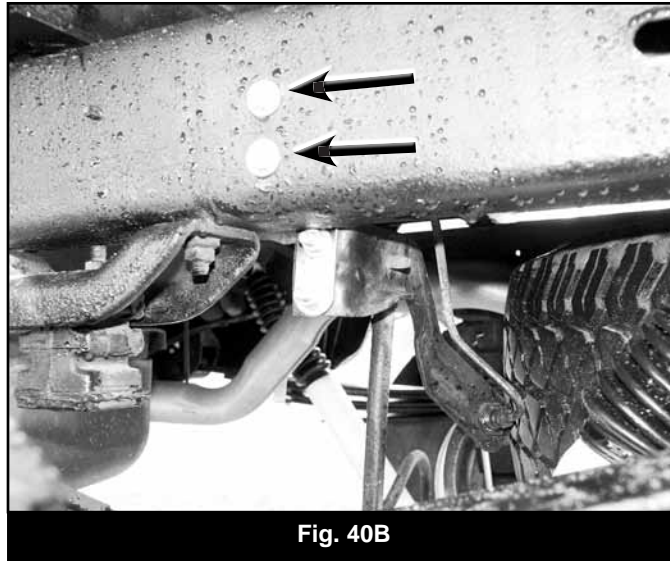
ⓘ *Note: The fuel tank may need to be moved to allow removal of the front hanger bolts.*

All Applications

22. Install the provided BDS shocks with the OE hardware.
23. Install the provided brake line drop bracket (01122) to the frame where the OE bracket was originally located using the OE hardware (Fig 40A,B). Tighten the hardware securely.



Fig. 40A



24. Attach the rear brake line and vent tube bracket to the new bracket line drop with the 5/16" x 1-1/4" bolts, nuts and 5/16" USS washers in bolt pack 606. Tighten hardware securely.
25. Install the wheels and lower the vehicle to the ground.
26. Bounce the vehicle to settle the suspension and torque the u-bolts to 100-120 ft-lbs.
27. If the springs were replaced, torque the shackle to 92 ft.lbs. and the hanger bolts to 81 ft-lbs.
28. Double check all hardware.
29. The exhaust must be modified and the front driveshaft reinstalled with the OE hardware.

Final Check

1. A front end alignment must be performed.
2. Adjust headlights
3. Check all moving parts for clearance.
4. Check all fasteners after 500 miles.

NOTICE TO DEALER/INSTALLER

These instructions, the warning card, and included decals must be given to the owner of this BDS Suspension product.

For questions, technical support and warranty issues relating to this BDS Suspension product, please contact your distributor/installer before contacting BDS Suspension directly.

Sold/Installed by: